

POOL COVERS 10/02

THERMAL COVERING

✓ Technical features

Points common to all Solar Covers:

- Covers are measured to the nearest m²
- When calculating cover prices, round up to the nearest m²
- Covers come complete with a solar protector sheet to be used when the cover is off the pool
- Covers are made oversized
- Non-hemmed covers are rectangular and are to be trimmed on site
- Add shaping charge for non-hemmed covers, if exact sizes are required
- Covers over 12m should have reinforcements and a leading edge
- All covers fitted with a 'Commercial Leading Edge' will be rolled and could therefore incur a 'Commercial Carriage Charge'
- All other Solar Covers are bagged



PREMIUM DOMESTIC LEADING EDGE

- Strong and durable PVC coated polyester netting
- Polyethylene foam inserts for added buoyancy
- Easily installed on new or existing covers by end user

- Complete with fixings and pull cord, including our new slide lock clip
- Also available in black

Note: Covers 10m² and over will be charged at bulky rate and are excluded from free delivery

🔍 Models

PRODUCT CODE	DESCRIPTION
CLE012BLC	LEADING EDGE KIT FOR POOL 12' (3.65 m model) - BLUE
CLE016BLC	LEADING EDGE KIT FOR POOL 16' (4.8m model) - BLUE
CLE020BLC	LEADING EDGE KIT FOR POOL 20' (6.10m model) - BLUE
CLE012BKC	LEADING EDGE KIT FOR POOL - 12 ft - BLACK
CLE016BKC	LEADING EDGE KIT FOR POOL - 16 ft - BLACK
CLE020BKC	PREMIUM DOMESTIC LEADING EDGE KIT FOR POOL - 20 ft - BLACK

PRODUCT CODE	DESCRIPTION
HEM400S	Hemming for Solar Covers per m. run
SHPMCOMS	Shaping Surcharge per m ²
CUTCOMS	Cut-out Charge for Floating Covers
SHPACOMS	Charge for Shaping Bay
FITSTRAPS	Attach Strap Set to Cover (per strap)
WEB025	25m Roll of Blue Webbing (25mm)
EYELETS	Reinforced Eyelet



Note: Welding on solar covers can lead to a slight waving. Cover guarantee is void if pool temperature exceeds 29°C or SPATA standards for chemical and TDS levels are not met.

POOL COVERS 10/02

THERMAL COVERING

SOLAR GUARD 500

✓ Technical features

- Clear top, tinted translucent underside
- 500 micron
- Increases pool temperature by up to 8°C
- Eliminates water evaporation by 98% +
- Cuts chemical consumption by up to 30%
- Lowers energy consumption by over 50%
- 6 year pro-rata warranty (UK & Eire only)
- Sol+Guard 180 has higher UV stabilisation which is designed for use in hotter climates



🔍 Models

PRODUCT CODE	DESCRIPTION
PGS580	SOLAR GUARD 500 MICRON POOL COVER - PER m ²

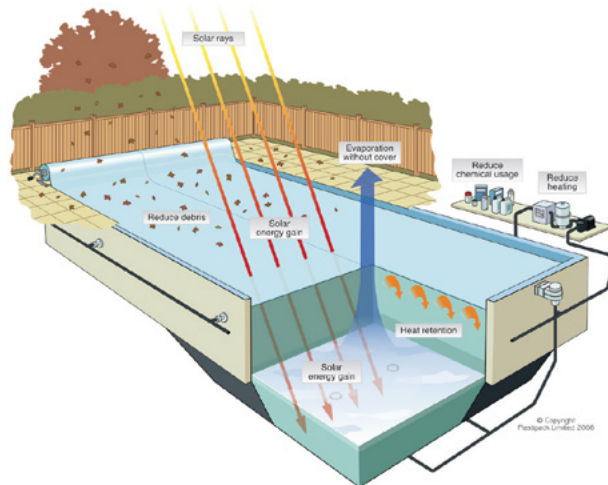

Solar Gains

The Sol+Guard 500 micron, transparent, swimming pool cover material transmits 80% of the sun's energy into the visual and IR spectrum through the material to heat the water in the swimming pool. Sol+Guard has been seen to increase pool temperatures by up to 8°C above the ambient pool temperature, reducing the heating demand by up to 70%.



Heat Retention

The unique profile of the GeoBubble technology air cells provide both buoyancy and an insulative air gap to control heat transfer, enabling the material to manage the pool environment and keep the pool at the desired temperature.



Evaporation Control

Our materials reduce water losses through evaporation by working as a barrier between the water's surface and the atmosphere. By simply covering the pool with the material, evaporation is reduced by over 98%, resulting in the preservation of the water resources and increased temperature within the swimming pool.



Debris Control

Covering your pool prevents dirt, leaves, insects and other debris from entering the pool, maintaining a clean, pleasant swimming environment and reducing chemical demand.

POOL COVERS

POOL COVERS 10/02 THERMAL COVERING

BLUE 400

✓ Technical features

- 400 micron
- UV stabilised
- 0.37Kg per sq.m
- Eliminates water evaporation by 98%+
- Reduce debris contamination
- Increase pool temperature
- Reduce chemical consumption
- Reduce energy consumption



🔍 Models

PRODUCT CODE	DESCRIPTION
PSC400	BLUE 400 MICRON POOL COVER - PER M ²



Evaporation Control

Our materials reduce water losses through evaporation by working as a barrier between the water's surface and the atmosphere. By simply covering the pool with the material, evaporation is reduced by over 98% resulting in the preservation of the water resources and increased temperatures within the swimming pool, saving water and preventing evaporative cooling.



Heat Retention

The unique profile of the GeoBubble technology air cells provide both buoyancy and an insulative air gap to control heat transfer enabling the material to manage the pool environment and keep the pool at the desired temperature.



Temperature Increase

GeoBubble covers help to increase pool temperature by allowing for solar gains, as well as retaining the gained heat by providing a barrier to evaporation and an insulative air gap.



Debris Control

Covering your pool prevents dirt, leaves, insects and other debris from entering the pool, maintaining a clean, pleasant swimming environment and reducing chemical demand.

POOL COVERS 10/02

THERMAL COVERING

ENERGYGUARD

✓ Technical features

- 500 micron
- Eliminates water evaporation by 98%+
- Reduces chemical consumption by up to 60%
- Lowers energy consumption by over 60%
- Reduces debris contamination
- Reduces filtration time by up to 50%
- Can be used as a winter cover
- Reduces debris contamination
- EnergyGuard 180 has higher UV stabilisation which is designed for use in hotter climates
- Now available in a woven top sheet for extra strength

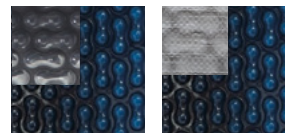

🔍 Models

PRODUCT CODE	DESCRIPTION
PGE500B	EnergyGuardTM per m ² 140 UV Protection
PGE580B	EnergyGuardTM per m ² 180 UV Protection



Award Winning Material

EnergyGuard Selective Transmission has been awarded the 2018 Business Innovation Award for delivering significant societal and economic impact through the application of physics.



Selective Transmission

The bubble layer of the material uses a patented midnight blue pigment combination which gives the material its selective transmission properties. The pigment formulation works as a selective filter absorbing the visible wavelengths responsible for photosynthesis. This absorbed energy is passed to the pool through conduction, while the transmission properties of the bubble layer allows for Infrared Radiation (IR) wavelengths to pass through the material and be directly absorbed by the water.



Debris and Algae Control

As well as preventing debris from entering the pool, EnergyGuard Selective Transmission helps maintain a pleasant, warm swimming environment by using light filtration technology to absorb the wavelengths that promote the growth of algae, reducing the cost and time spent on maintenance.



Heat Retention

The unique profile of the GeoBubble technology air cells provide both buoyancy and an insulative air gap to control heat transfer enabling the material to manage the pool environment.



Evaporation Control

Our materials reduce water losses through evaporation by working as a barrier between the water's surface and the atmosphere. By simply covering the pool with the material, evaporation is reduced by over 98%, resulting in the preservation of the water resources and increased temperature within the swimming pool.

POOL COVERS

POOL COVERS 10/02

THERMAL COVERING

COOLGUARD ULTRA 500

✓ Technical features

- 500 micron
- Minimises daily solar gains by 55%
- Maintains a 10% cooler pool
- Reduces energy consumption by over 50%
- Reduces chemical consumption by up to 50%
- Eliminates water evaporation by 98%
- Reduces debris contamination
- Saves money and reduces carbon footprint of your pool
- 6 year+ pro-rata warranty (UK & Eire only)
- Geobubble™ Technology
- Sol+Guard 180 has higher UV stabilisation which has been designed for use in hotter climates



🔍 Models

PRODUCT CODE	DESCRIPTION
PGC500	COOL GUARD UNLTRA 500 MICRON POOL COVER - PER M ²



Heat Reflection

CoolGuard Ultra's increased reflectivity provides a dramatic improvement to the regulation of the pool's temperature. Its Glacial Blue colour brings a 25% improvement in reflectivity across the visible and IR spectrum, providing a barrier to reduce solar gains, ensuring a cooler, more refreshing swimming temperature.



Evaporation Control

Our materials reduce water losses through evaporation by working as a barrier between the water's surface and the atmosphere. By simply covering the pool with the material, evaporation is reduced by over 98%, resulting in the preservation of the water resources and increased temperature within the swimming pool.



Heat Insulation

The unique profile of the Geobubble technology air cells provide both buoyancy and an insulative air gap to control heat transfer enabling the material to manage the pool environment and keep the pool at the desired temperature.



Debris Control

Covering your pool prevents dirt, leaves, insects and other debris from entering the pool, maintaining a clean, pleasant swimming environment and reducing chemical demand.



POOL COVERS

POOL COVERS 10/02

THERMAL COVERING

SUPER COVER (5MM)

✓ Technical features

- 5mm polyolefin closed cell foam cover
- Tough woven top and bottom sheet for heat retention and strength
- Shaped and hemmed to your specification
- Weight: 0.42kg per sq m.
- 29°C maximum temperature
- 3 year pro rata guarantee
- Hemming charge included (per square metre)

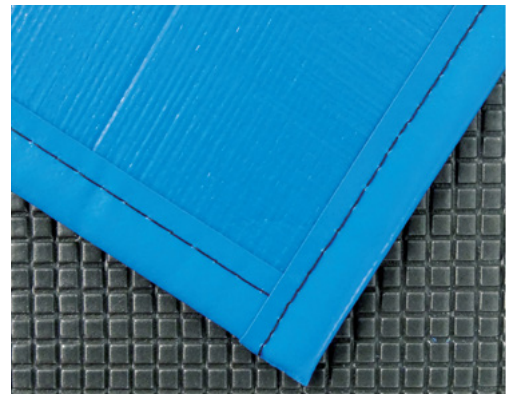

🔍 Models

PRODUCT CODE	DESCRIPTIONS
PSU100	SUPERCOVER 5MM - PER M ²

PREMIUM COVER (8MM)

✓ Technical features

- 8mm foam centre with embossed underside
- Polyolefin woven fabric top laminate with UV stabilised coating
- Shaped and hemmed to your specification
- Suitable for hydrotherapy pools
- Weight: 0.53kg per sq m.
- 29°C maximum temperature (39°C max for hydrotherapy pools)
- 4 year pro rata guarantee (one year on hydrotherapy pools)
- Hemming charge included (per square metre)

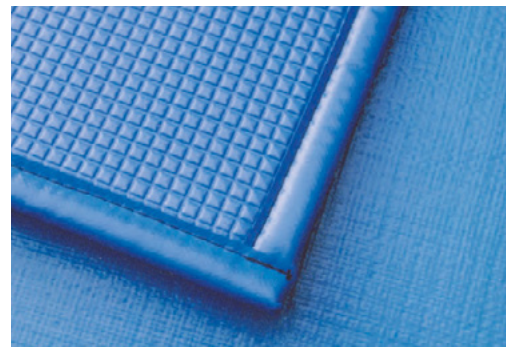

🔍 Models

PRODUCT CODE	DESCRIPTION
PPR100	SUPERCOVER 5MM - PER M ²

COVER REPAIR

🔍 Models

PRODUCT CODE	DESCRIPTION	SUITABLE FOR
PLR150	COVER REPAIR TAPE 50MM x 33M ROLL SUITABLE	ALL COVERS
PLR255	REPAIR MATERIAL 0.15M WIDE PER M SUITABLE	SUPER COVERS



THERMAL COVERING

HEAT RETENTION COVERS





✓ Technical features

Over 90% of a pool's heat is lost via the water surface. This can be considerably reduced by using a heat retention cover.

- Reduces humidity levels
- Reduces the need for heating and ventilation
- Installs onto most pool types including free-form pools
- Covers should recoup their costs from energy saving within twelve months
- Covers over 12m should have reinforcements and a leading edge
- Covers are despatched in roll form
- Packaging adds approximately 150mm to cover width
- Designed for use in hotter climates

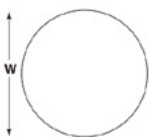
HEAT RETENTION COVERS PRICING FORMULA

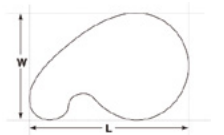
Follow the calculation method to find the chargeable area (CA) to the nearest M2

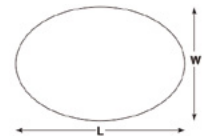
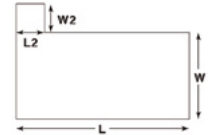
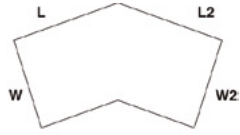
RECTANGULAR	CALCULATION	SHAPED	CALCULATION
<p>STANDARD SIZE COVER WITH STEP CUT-OUT</p> 	<p>Cover Price = Cover Area (CA) x Price per m PLUS 1 x cut-out charge CUTCOM per ladder</p> <p>RECTANGULAR</p> <p>CA = L x W Cover price = CA x Price per m</p>		<p>CA = W x W Cover price CA x (Price per m + shaping surcharge per m)</p> <p>OVEL</p> <p>CA = W x W Cover price CA x (Price per m + shaping surcharge per m)</p>
	<p>ROMAN END</p> <p>CA = L x W List Price = CA x Price per m Add 1 x Charge for bay shaping</p>		<p>FREEFORM/KIDNEY</p> <p>CA = W x W Cover price CA x (Price per m + shaping surcharge per m)</p>
	<p>DOUBLE ROMAN END</p> <p>CA = L x W List Price = CA x Price per m Add 2 x Standard Charge for bay shaping</p>		<p>SHAPED OVAL/PEAR</p> <p>CA = W x W Cover price CA x (Price per m + shaping surcharge per m)</p>
	<p>WALK IN STAIRS/BAYS</p> <p>CA = L x W + (L2 x W2) List Price = CA x Price per m Add 1 x Charge for bay shaping</p>		<p>DOG LEG/LAZY 'L'</p> <p>CA = L x W + (L2 x W2) Cover price CA x (Price per m + shaping surcharge per m)</p>

POOL COVERS 10/02

THERMAL COVERING



SLIDELOCK TELESCOPIC REEL

✓ Technical features

- Polished stainless steel end stands
- Anodised aluminium tubes
- Plastic end bosses and steering wheels
- Straps connect to tubes by our unique slide and lock fixing
- Locking device holds the tube in position, stopping the cover from unwinding
- Range of different end stands
- Optional castor pack
- Small slidelock tubes go from 3.7m to 4.9m, for covers up to a maximum 4.6m width (12' to 16' tubes - 15' maximum cover width)
- Large slidelock tubes go from 5.0m to 6.7m, for covers over 4.6m up to a maximum 6.4m width (16'5" to 22' tubes - 21' maximum cover width)
- Notes: Reels should be set up to have a maximum 300mm overlap each side
- Maximum recommended area of material on both reels is 75m²
- Cover/tube overlap should be kept to a minimum
- Some flexing of the tube may occur with larger covers

🔍 Models

PRODUCT CODE	DESCRIPTION	PRODUCT CODE	DESCRIPTION
PRD113	140 cm Elastic Cord with Toggle Ends (Pk of 8)	PRD20040BK	Pack of 10 Black Universal Strap Sets (individually packed)
PRD115	Elasticated Quick Fit Strap Kit (Pk of 3)	PRD20041	Pack of 10 Blue Universal Strap Sets (not individually packed)
PRD125	Pair of Threaded Deck Anchors	PRD20041BK	Pack of 10 Black Universal Strap Sets (not individually packed)
PRD130	Additional Height of 300mm Per Pair	PRD020PFB	Pack of 20 Blue Press Fix Connectors
PRD151	Pack of 6 Plated Castors (43mm tube) contains x4 braked and x2 unbraked	PRD020PFBK	Pack of 20 Black Press Fix Connectors
PRD161	Pack of 6 Stainless Steel Castors (43mm tube) contains x4 braked and x2 unbraked	PRD050PFB	Pack of 50 Blue Press Fix Connectors
PIRA110	Pack of 10 Blue Piranha Clips	PRD050PFBK	Pack of 50 Black Press Fix Connectors
PIRA150	Pack of 50 Blue Piranha Clips	PRD100PFB	Pack of 100 Blue Press Fix Connectors
PIRA210	Pack of 10 Black Piranha Clips	PRD100PFBK	Pack of 100 Black Press Fix Connectors
PIRA250	Pack of 50 Blue Piranha Clips	SLC00110	Pack of 10 Blue Slidelock Clips
PRD20040	Pack of 10 Blue Universal Strap Sets (individually packed)	SLC00210	Pack of 10 Black Slidelock Clips

WEDGES (PACK OF 10)

PRODUCT CODE	DESCRIPTION
RTS100	Reel Thumb Screws
WED100	Large Inner Wedges
WED200	Small Outer Wedges
RTS100B	Reel Thumb Screws Black
WED100B	LARGE INNER WEDGES BLACK
WED200B	Small Outer Wedges Black



Elastic cords with toggle ends Kit - PRD113

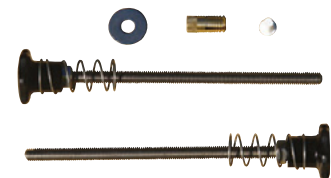

Deck Anchors - PRD125



Strap Kit - PRD115



Press Fix Connector - PRD020PFB

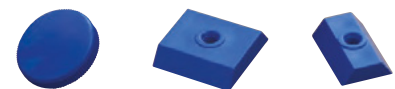

RTS100 - WED100 - WED200



Piranha Clip - PIRA110/PIRA150

Slidelock Clip, Blue - SLC00110 Slidelock Clip, Black - SLC00210

THERMAL COVERING

SLIDELOCK TELESCOPIC REEL

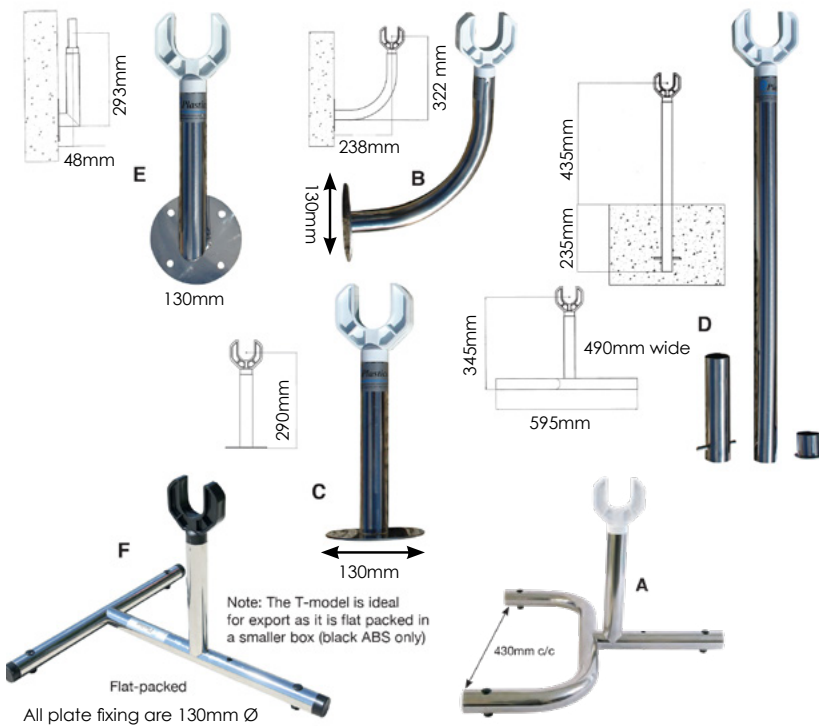

All plate fixing are 130mm Ø

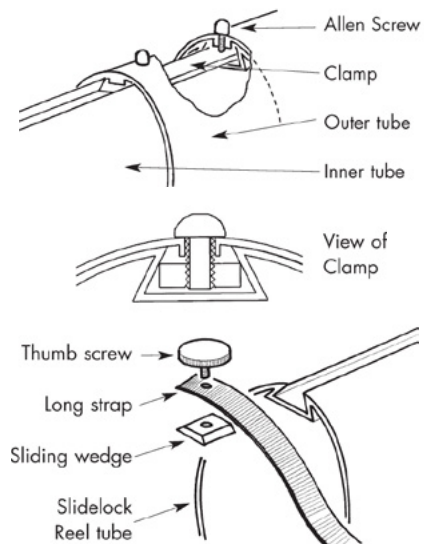

Any fixed domestic end stands can have an additional height added at the price code. 16mm drill bit needed. Extensions up to an added 300mm are 1x PRD130S charge, over this and to a maximum of 500mm, 2x PRD130S are to be charged. **Note:** Dimensions on extensions refer to metalwork only.

Models

PRODUCT CODE	DESCRIPTION (Complete Telescopic Reel)
PRD2043K	43mm Small Standard Slidelock Reel (A)
PRD2143K	43mm Small Wall Mounted Slidelock Reel (B)
PRD2243K	43mm Small Base Plate Slidelock Reel (C)
PRD2343K	43mm Small Sleeve Mounted Slidelock Reel (D)
PRD2443K	43mm Small Side Wall Mounted Slidelock Reel (E)
PRD200ETBK	38mm T-Model Space Saver Flat-packed (F)

PRODUCT CODE	DESCRIPTION (Complete Telescopic Reel)
PRD2543K	43mm Large Standard Slidelock Reel (A)
PRD2643K	43mm Large Wall Mounted Slidelock Reel (B)
PRD2743K	43mm Large Base Plate Slidelock Reel (C)
PRD2843K	43mm Large Sleeve Mounted Slidelock Reel (D)
PRD2943K	43mm Large Side Wall Mounted Slidelock Reel (E)
PRD205ETBK	38mm T-Model Space Saver Flat-packed (F)

REDUCTION GEARBOX

43mm Small Slidelock (complete)

PRODUCT CODE	DESCRIPTION
PRD2043RGK	Standard Slidelock Reel with Reduction Gearbox
PRD2143RGK	Wall Mounted Slidelock Reel with Reduction Gearbox (B) *
PRD2243RGK	Base Plate Slidelock Reel with Reduction Gearbox (C) *
PRD2343RGK	Sleeve Mounted Slidelock Reel with Reduction Gearbox (D) *
PRD2443RGK	Side Wall Mounted Slidelock Reel with Reduction Gearbox (E)
PRD200TWRGK	T-Model (F) (black ABS only)

43mm Large Slidelock (complete)

PRODUCT CODE	DESCRIPTION
PRD2543RGK	Standard Slidelock Reel with Reduction Gearbox (A)
PRD2643RGK	Wall Mounted Slidelock Reel with Reduction Gearbox (B) *
PRD2743RGK	Base Plate Slidelock Reel with Reduction Gearbox (C) *
PRD2843RGK	Sleeve Mounted Slidelock Reel with Reduction Gearbox (D) *
PRD2943RGK	Side Wall Mounted Slidelock Reel with Reduction Gearbox (E)
PRD205TWRGK	T-Model (F) (black ABS only)

THERMAL COVERING

REDUCTION GEARBOX

✓ Technical features

- Revolutionary product
- Fits both Plastica Slidelock domestic reels
- Discreet and made to match the original boss
- Reduction makes winding reels easier
- Retro fits to existing Slidelock reels on site
- Includes all necessary tools and instructions
- Aerospace industry gearing for strength and reliability



🔍 Models

PRODUC CODE	DESCRIPTION
RGK007	3:1 REDUCTION GEARBOX FOR SLIDELOCK REEL

POWER PACK

✓ Technical features

- Semi-automatic motorisation for domestic reels up to 75 sq.m
- Motor fits Plastica Slidelock reel (and Reel Easy, using adaptors)
- With built-in brake, limit switches and variable start delay timer
- Includes hand held remote control with up to 30m range
- S.E.L.V. can be mounted in pool area
- Built in battery back-up & 24V DC Power Supply/Charger
- Powerful motor with overload protection and 15m of cable
- Complies with existing wiring regulations
- Safe extra low voltage control box for safety (24V DC)
- Charger with 1.8m cable requires 6Amp 230V AC socket



🔍 Models

PRODUC CODE	DESCRIPTION
PRD604K	POWER PACK 24V MOTOR SYSTEM
PRD605RB	KEY SWITCH WITH 15M CABLE

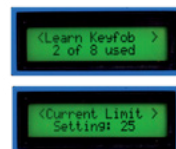
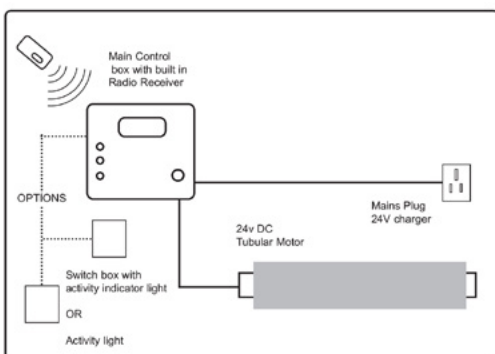

- The microprocessor Control Panel with LCD display has multiple menu options:
- Variable current limit
- Jammed cover reversing function
- Maximum of 8 radio remote controllers (1 supplied)
- Variable delay for button operated closing
- Variable delay for transmitter closing
- Selectable charger type

POOL COVERS 10/02

THERMAL COVERING

MOBILE

✓ Technical features

- Suitable for smaller commercial pools
- Stainless steel frame with nylon end bosses
- 127mm diameter aluminium tube
- 127mm braked castors
- Note: If the cover length exceeds the maximum, as indicated, then a 165mm aluminium tube is required. Call 'Customer Services' for a quote. Reduction gear box recommended for covers over 140 sq m.



📏 Dimensions

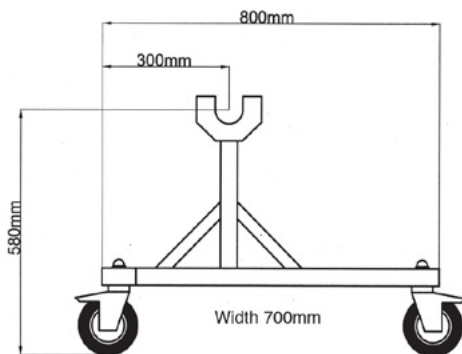

🔍 Models

PRODUCT CODE	DESCRIPTION	MAX. N POOL LENGTH
PPB212	MOBILE REEL SYSTEM 127MM DIA, 3.66M	50
PPB214	MOBILE REEL SYSTEM 127MM DIA, 4.27M	50
PPB216	MOBILE REEL SYSTEM 127MM DIA, 4.88M	50
PPB218	MOBILE REEL SYSTEM 127MM DIA, 5.49M	50
PPB220	MOBILE REEL SYSTEM 127MM DIA, 6.1M	50
PPB222	MOBILE REEL SYSTEM 127MM DIA, 6.71M	34
PPB224	MOBILE REEL SYSTEM 127MM DIA, 7.32M	25
PPB226	MOBILE REEL SYSTEM 127MM DIA, 7.92M	20
PPB228	MOBILE REEL SYSTEM 127MM DIA, 8.53M	17
PPB230	MOBILE REEL SYSTEM 127MM DIA, 9.14M	14
PPB232	MOBILE REEL SYSTEM 127MM DIA, 9.75M	10

POOL COVERS

POOL COVERS 10/02

THERMAL COVERING

PIGGYBACK MOBILE

✓ Technical features

- For pools up to 13.7m wide
- Ideal when two covers are required for pools over 9.14m wide
- Dual tubes take both covers supported by a pair of mobile end stands
- Detachable cover with quick-fit snap connectors
- Stainless steel frame with nylon end bosses
- 127mm diameter aluminium tube
- 152mm stainless steel braked castors

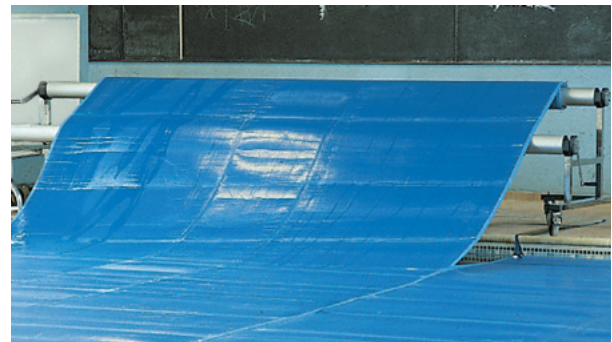

📏 Dimensions

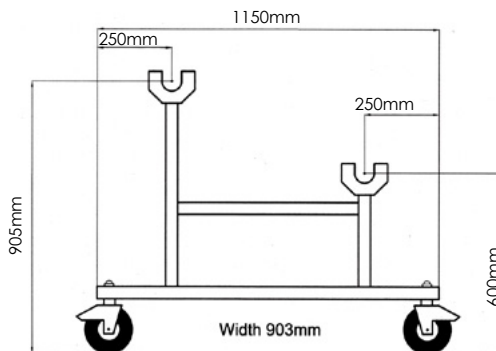

🔍 Models

PRODUCT CODE	DESCRIPTION	MAX. N POOL LENGTH
PPB012	PIGGYBACK MOBILE DOUBLE REEL 127MM DIA, 3.66M	50
PPB014	PIGGYBACK MOBILE DOUBLE REEL 127MM DIA, 4.27M	50
PPB016	PIGGYBACK MOBILE DOUBLE REEL 127MM DIA, 4.88M	50
PPB018	PIGGYBACK MOBILE DOUBLE REEL 127MM DIA, 5.49M	50
PPB020	PIGGYBACK MOBILE DOUBLE REEL 127MM DIA, 6.1M	50
PPB022	PIGGYBACK MOBILE DOUBLE REEL 127MM DIA, 6.71M	50
PPB024	PIGGYBACK MOBILE DOUBLE REEL 127MM DIA, 7.32M	50
PPB20013	QUICK RELEASE STRAP KIT 5"	34
PPB20014	QUICK RELEASE STRAP KIT 7"	25

Piggyback with reduction gearbox

There is an additional cost per reel when gearboxes are required. Please add a "G" to the end of the reel code when ordering – ie. PPB012G

POOL COVERS

THERMAL COVERING

COMMERCIAL REEL SYSTEM

✓ Technical features

- Suitable for most smaller commercial pools
- Nylon end bosses and anodised tube
- Optional reduction gearbox
- Highly polished stainless steel end stands as standard
- White powder coating available on request
- Approximate weight of each end stand including bearing is 10kg plus 2kg extra per 240mm run of tube

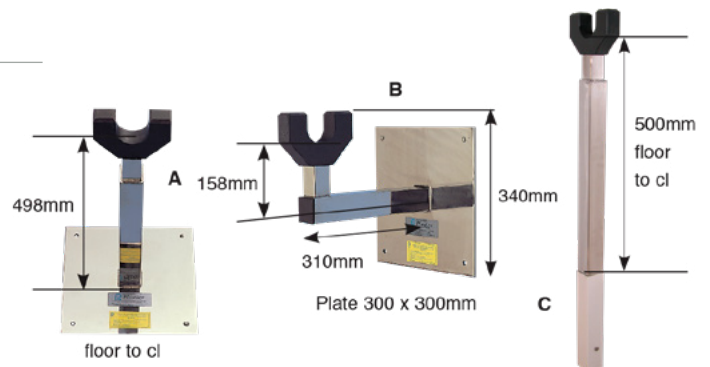

🔍 Models

PRODUCT CODE	DESCRIPTION	DIA
PCR012	FIXED MANUAL TUBE PACKS	DIA 3.66M
PCR014	FIXED MANUAL TUBE PACKS	DIA 4.27M
PCR016	FIXED MANUAL TUBE PACKS	DIA 4.88M
PCR018	FIXED MANUAL TUBE PACKS	DIA 5.49M
PCR020	FIXED MANUAL TUBE PACKS	DIA 6.10M
PCR022	FIXED MANUAL TUBE PACKS	DIA 6.71M
PCR024	FIXED MANUAL TUBE PACKS	DIA 7.32M
PCR026	FIXED MANUAL TUBE PACKS	DIA 7.92M
PCR028	FIXED MANUAL TUBE PACKS	DIA 8.53M
PCR030	FIXED MANUAL TUBE PACKS	DIA 9.14M
PCR032	FIXED MANUAL TUBE PACKS	DIA 9.75M
PCR002	BASE PLATE END STANDS	-
PCR004	WALLMOUNT END STANDS	-
PCR006	SLEEVE MOUNT END STANDS	-
PCR120	0.3M ADDED HEIGHT TO REEL SYSTEM PER PAIR	-

	LENGTH m						
	10	15	20	25	30	33	50
PCR012	0%	0%	0%	0%	0%	0%	0%
PCR014	0%	0%	0%	0%	0%	0%	0%
PCR016	0%	0%	0%	0%	0%	0%	0%
PCR018	0%	0%	0%	0%	0%	0%	0%
PCR020	0%	0%	0%	0%	0%	0%	A
PCR022	0%	0%	0%	0%	0%	A	A
PCR024	0%	0%	0%	0%	A	A	-
PCR026	0%	0%	0%	A	A	-	-
PCR028	0%	0%	A	A	-	-	-
PCR030	0%	A	A	-	-	-	-
PCR032	0%	A	A	-	-	-	-

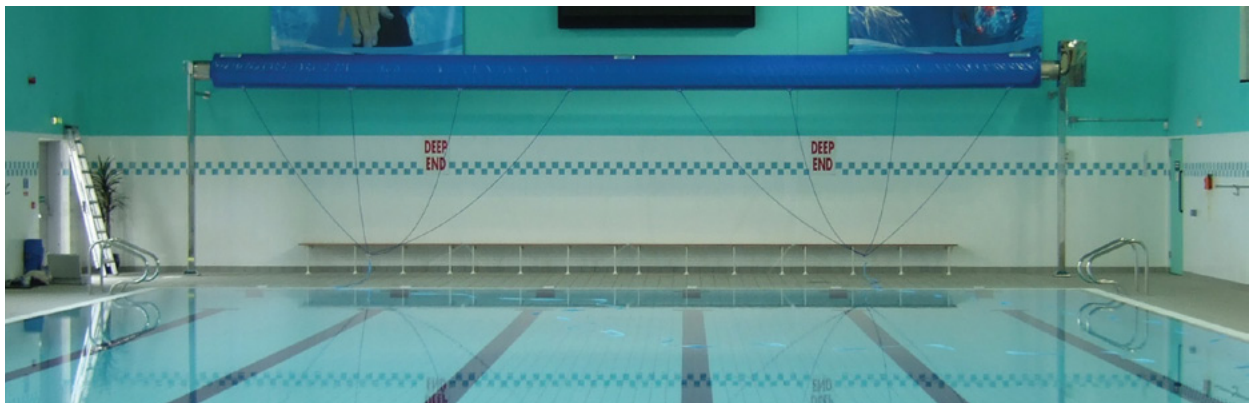

POOL COVERS 10/02

THERMAL COVERING

LIGHT COMMERCIAL MOTORIZED

✓ Technical features

- Ideal for small commercial swimming pools
- Ultra quiet motor with soft start - soft stop mechanism
- Manufactured from stainless steel
- Maximum cover size 170 sq m.
- 9m maximum standard tube length
- 168mm tube diameter
- Key switch and remote control
- Auto stop end-of-run settings



FULL COMMERCIAL STANCHION MOTORISED

✓ Technical features

- Ultra quiet motors with soft start and soft stop mechanism
- 304mm diameter stainless steel tubing
- Maximum cover capacity of 600 sq m.
- 14m maximum tube length
- Key switch and remote control operation
- Auto stop end of run settings



THERMAL COVERING

WIND RESISTANT WIRES

✓ Technical features

- Recommended for all outdoor pool covers
- Helps protect from lifting in winds up to Gale Force 5 (30km/h)
- Stainless steel wire fitted inside hemming and fixed at pool ends
- Requires wires on lengths and widths, together with two of each end fitting kit
- Note: Wires can only be fitted at the time of manufacture.
- Not guaranteed to make a pool cover windproof
- Covers should be stored on a reel system in winds over Gale Force 5 (30km/h)

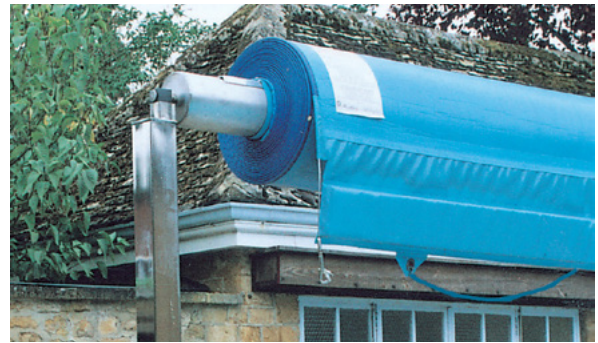

Q Models

PRODUCT CODE	DESCRIPTION
WRW001	WIND WIRES PER LINEAR METER
WRT001	TOWING END FITTING KIT
WRR001	REEL END FITTING KIT

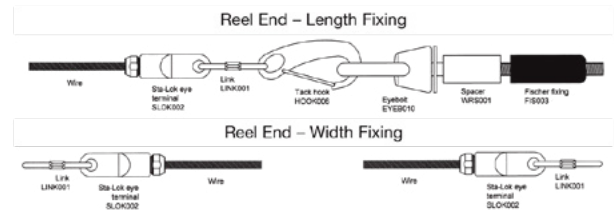
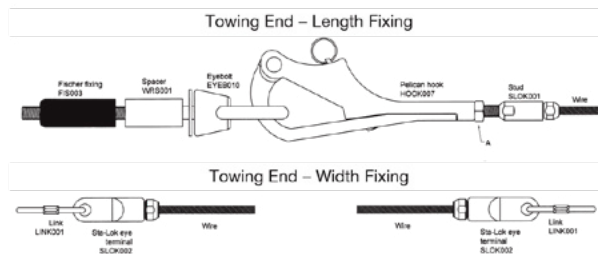

REFLECTIVE STORAGE COVER

✓ Technical features

- Reduces the temperature of a stored cover by over 30°C
- Extends the life of your cover by protecting from sun damage
- UV stabilized



Q Models

PRODUCT CODE	DESCRIPTION
PSC801	REFLECTIVE STORAGE COVER 25M ROLL x 1M WIDE
PSC820	REFLECTIVE STORAGE COVER 6M LENGTH
PRD115	ELASTICATED QUICK FIT STRAP KIT (PACK OF 3)
PRD113	140 CM ELASTIC CORD WITH TOGGLE ENDS (PACK OF 8)

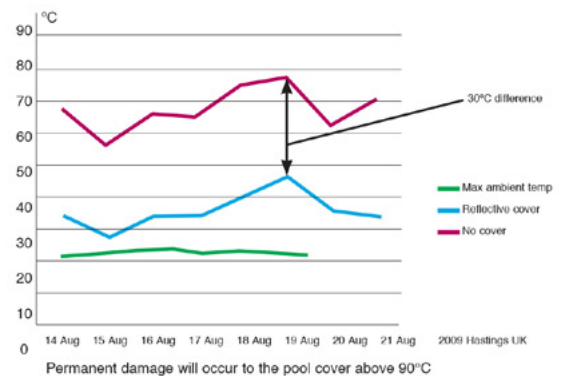



Your global partner since 1974. Trusted for superior quality and exceptional innovations.



Head Office

AQUA S.p.A

42018 San Martino in Rio, Reggio Emilia
Italy - Via Crotti, 1
P: +39 0522 695805/85 - F: +39 0522 646160
aqua@aqua.it | www.aqua.it

AQUA S.p.A - POOL DIVISION

46043 Castiglione d. Stiviere, Mantova - Italy
P: +39 0376 671973 - F: +39 0376 940139
infopools@aqua.it | www.aqua.it



Branches

AQUA WATER SYSTEMS LTD

Unit 135 Oak Drive Hartlebury Trading Estate,
Worcestershire, DY10 4JB
P: +44 (0)1299 251050, F: +44 (0)1299 253704
sales@askaqua.co.uk | www.askaqua.co.uk

AQUA FILTRACION S.A.

Pol. Ind. Castellbisbal Sud 08755
Castellbisbal, Barcelona
P: +34 (0)93 7711855, F: +34 (0)93 7711772
info@aqua.es | www.aqua.es

AQUA SU ARITIMI SAN. VE MUH. TIC. LTD. STI.

Ferhatpasa Mahallesi Maresal Fevzi Cakmak
Cad. No:45 Pk.34888 Atasehir / Istanbul - Turkey
P: +90 216 661 60 60, F: +90 216 661 68 50
info@aqua.com.tr | www.aqua.com.tr

AQUA MIDDLE EAST FZC

1J-07/4 and 1J-07/3 - Hamriyah Free Zone
P.O.Box 42585 Sharjah - United Arab Emirates
P: +971 6 526 0563, F: +971 6 526 0564
contact@aqua-me.ae
www.aqua-me.ae

AQUA WATER SYSTEMS INDIA PVT LTD

4A/4B/4C-,Puttappa Industrial Estate
Mahadevapura Post, White Field Road,
Bangalore 560 048
P: 0091 80 4152 1313, F: 0091 80 4152 1414
contact@aquaindia.in | sales@aquaindia.in
www.aquaindia.in

AQUA GROUP RUS

Juridical Address:
107014, Egerskaya str, 1, Moscow, Russia
Residence Address:
127081, Chermianskaya str, 3, Moscow, Russia
P: +7 495 6458078, F: +7 495 969 2413
mail@aqua-italy.ru | www.aqua-italy.ru
www.aqua.it

AQUA GROUP LLC

Office : Regus – Sarayat EL Maadi, Egypt
Management & Warehouse : Plot no 2-2nd service
axe, 2nd Industrial Zone, October, Egypt
P: +20 2 3820 2259 | info@aqua.eg