

CHEMICAL DOSING EQUIPMENT | 08/01

PERISTALTIC DOSING PUMPS



TEC POOL

For private pools with a volume up to 200m³ and timed dosing of chlorine or other liquid disinfectants.

✓ Technical features

- Digital peristaltic pump for dosing chemicals in pools (chlorine, Hydrogen peroxide, flocculant, anti-algae)
- Relay or cycle mode programmable functioning
- Inhibit input with specific cable to activate dosing (to be connected to circulation pump)
- The pump includes a kit and accessories for correct installation (collar excluded)
- Power supply: standard 230V AC 50Hz/60Hz
- Absorption: 15W (max)
- Level inputs: standard
- Inhibit input: 230V AC to activate and allow dosing (circulation pump)
- Switch: on/off/prime

Standards:

- No. 2004/108/CE EMC directive
- No. 2006/95/CE 'DBT low voltage directive'
- No. 2011/65/UE, 2002/96/CE 'RoHS and WEEE directives'

Package dimensions:

- L 250mm x H 145mm x W 265mm

📏 Dimensions

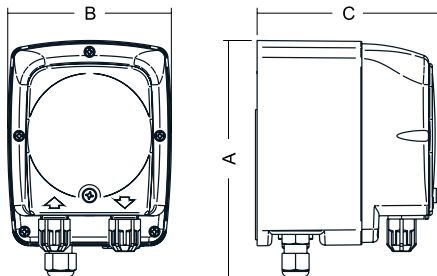

🔍 Models

| PRODUCT CODE | POWER | FLOW RATE l/h | PRESSURE bar | WATT | PIPE | PACKING | WEIGHT kg | VOLUME m ³ |
|------------------|-------------|------------------|-----------------|------|------------|---------|--------------|--------------------------|
| ADT100401001W000 | 100-240 VAC | 4 | 1 | 7 | SANTOPRENE | 1 | 1.6 | 0.0053 |
| ADT100601001W000 | 100-240 VAC | 6 | 1 | 7 | SANTOPRENE | 1 | 1.6 | 0.0053 |

🛒 Installation kit

| PRODUCT CODE | DESCRIPTION | IMAGES |
|--------------|---------------------------|--------|
| KITPDP0005 | Installation kit TEC-POOL | |

CHEMICAL DOSING EQUIPMENT | 08/01

PERISTALTIC DOSING PUMPS



SIMPOOL-AUTOMATIC

For private pools with a volume up to 200m³ and automatic dosing of hydrogen peroxide or other liquid substances, upon activation of the circulation pump

✓ Technical features

- Digital peristaltic pump for automatic dosing of chemicals in pools (chlorine, hydrogen peroxide, flocculant, anti-algae) by simply setting the water volume, operating times and product dosing requirements
- Daily operation by flow sensor or inhibit input with specific cable to activate and allow the dosing (to be connected to circulation pump)
- The pump includes a kit and accessories for correct installation (collar excluded)
- Overdose signalling and correction under dosages
- Power supply: standard 230V AC 50Hz/60Hz
- Absorption: 15W (max)

- Level inputs: standard
- Inhibit inputs: 230V AC to activate and allow dosing (circulation pump) or flow sensor
- Switch: on/off/prime

Standards:

- No. 2004/108/CE EMC directive
- No. 2006/95/CE 'DBT low voltage directive'
- No. 2011/65/UE, 2002/96/CE 'RoHS and WEEE directives'

Package dimensions:

- L 250mm x H 145mm x W 265mm

📏 Dimensions

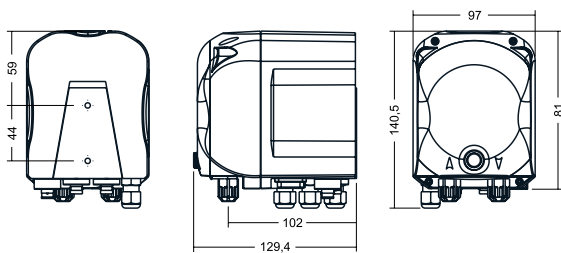

🔍 Models

| PRODUCT CODE | POWER | FLOW RATE l/h | PRESSURE bar | WATT | PIPE | PACKING | WEIGHT kg | VOLUME m ³ |
|------------------|---------|---------------|--------------|------|------------|---------|-----------|-----------------------|
| ADS3002010000000 | 230 VAC | 1.4 | 1 | 10 | SANTOPRENE | 1 | 2.33 | 0.0096 |
| ADS3001010000000 | 230 VAC | 3 | 1 | 10 | SANTOPRENE | 1 | 2.33 | 0.0096 |
| ADS3003010000000 | 230 VAC | 6 | 1 | 10 | SANTOPRENE | 1 | 2.33 | 0.0096 |

🔒 Installation kit

| PRODUCT CODE | DESCRIPTION | IMAGES |
|--------------|------------------------------------|--------|
| KITPDP0203 | Installation kit Simpool AUTOMATIC | |

CHEMICAL DOSING EQUIPMENT | 08/01

PERISTALTIC DOSING PUMPS



SIMPOOL TIMER

For private pools with a volume up to 200m³ and timed dosing of chlorine or other liquid disinfectants.

✓ Technical features

- Digital peristaltic pump with built-in timer for dosing chemicals in pools
- Daily and weekly programmable settings
- Ideal for the dosing of chlorine, hydrogen peroxide, flocculant and anti-algae
- Inhibit input to allow the dosing but can be deactivated if required
- The pump includes a kit and accessories for correct installation (collar excluded)
- Power supply: standard 230V AC 50Hz/60Hz
- Absorption: 15W (max)
- Level inputs: standard
- Inhibit inputs: 230V AC to activate and allow the dosing (circulation pump)
- Switch: on/off/prime

Standards:

- No. 2004/108/CE EMC directive
- No. 2006/95/CE 'DBT low voltage directive'
- No. 2011/65/UE, 2002/96/CE 'RoHS and WEEE directives'

Package dimensions:

- L 250mm x H 145mm x W 265mm

📏 Dimensions

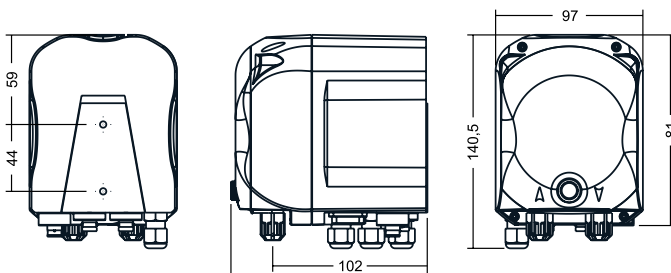

🔍 Models

| PRODUCT CODE | POWER | FLOW RATE l/h | PRESSURE bar | WATT | PIPE | PACKING | WEIGHT kg | VOLUME m ³ |
|------------------|---------|---------------|--------------|------|------------|---------|-----------|-----------------------|
| ADD80030100C0000 | 230 VAC | 3 | 1 | 10 | SANTOPRENE | 1 | 2.33 | 0.0096 |

🔧 Installation kit

| PRODUCT CODE | DESCRIPTION | IMAGES |
|--------------|------------------------------------|--------|
| KITPDP0203 | Installation kit Simpool AUTOMATIC | |

CHEMICAL DOSING EQUIPMENT | 08/01

PERISTALTIC DOSING PUMPS

SIMPOOL PH

For private pools up to 200m³ and dosing acid or alkaline corrector with the built-in pH tool.



✓ Technical features

- Digital peristaltic pump with built-in pH instrument
- Easy, precise and flexible use
- Continuous digital display even without circulation flow
- Flow presence/absence control through a connection to the circulation pump (Inhibit)
- Level probe compatible
- The kit includes: pH electrode, 4m suction/injection pipe, 2 pH buffer solutions to calibrate the electrode, wall fixing bracket and dowels, 2-in-1 electrode holder collar and product injection, suitable for DN50-63
- ADPSTC pipes, foot filter.
- Upon request, the compatible temperature-reading version is available (temperature probe not included).
- Power supply: standard 230V AC 50Hz/60Hz
- Absorption: 15W (max)
- Level inputs: standard
- Inhibit inputs: 230V AC to activate and allow dosing (circulation pump)

- Switch: on/off/prime

Light model:

- Range: 0-14pH (Adjustable range alarm)
- Pause mode

Pro model:

- Reduced Range: 5-9pH (specific for swimming pool use)
- Temperature probe connection*
- Range/maintenance/OFA/temperature alarm
- Statistics: Average pH measurement
- Buzzer

Standards:

- No. 2004/108/CE EMC directive
- No. 2006/95/CE 'DBT low voltage directive'
- No. 2011/65/UE, 2002/96/CE 'RoHS and WEEE directives'

Package dimensions:

- L 250mm x H 145mm x W 265mm

📏 Dimensions

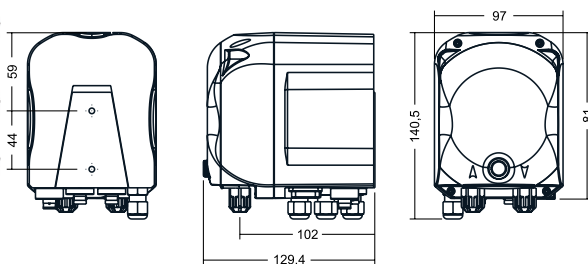

🔍 Models

| PRODUCT CODE | MODEL | POWER SUPPLY | FLOW RATE l/h | PRESSURE bar | WATT | PIPE | PKG | WEIGHT kg | VOLUME m ³ |
|------------------|----------------------|--------------|---------------|--------------|------|------------|-----|-----------|-----------------------|
| ADS100301000A000 | SIMPOOL LIGHT pH | 230 VAC | 3 | 1 | 15 | SANTOPRENE | 1 | 2.33 | 0.0096 |
| ADD300301000A000 | SIMPOOL PRO pH-Temp* | 230 VAC | 3 | 1 | 15 | SANTOPRENE | 1 | 2.33 | 0.0096 |

🛒 Installation kit

| PRODUCT CODE | DESCRIPTION |
|--------------|-----------------------------|
| KITPDP0201 | Installation kit Simpool PH |

CHEMICAL DOSING EQUIPMENT | 08/01

PERISTALTIC DOSING PUMPS

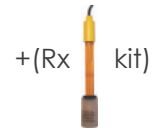

SIMPOOL RX

For private pools with a volume up to 200m³ and timed dosing of chlorine or other liquid disinfectants. Depending on the RX potential read through the built-in tool.

✓ Technical features

- Digital peristaltic pump with built-in Rx instrument
- Ideal for the proportional dosing of chlorine and other disinfectants in the pool
- Easy, precise and flexible use
- Continuous digital display even without circulation flow
- Flow presence/absence control through a connection to the circulation pump (Inhibit)
- Level probe compatible
- Power supply: standard 230V AC
- Absorption: 15W (max)
- Level inputs: standard
- Inhibit inputs: 230V AC to activate and allow dosing (circulation pump)
- Switch: on/off/prime
- Probe type: Rx electrode

Light model:

- Range: 0-999 mV (Adjustable range alarm)
- Pause mode

Pro model

- Reduced Range 500-900 mV (specific for swimming pool use)
- Range/maintenance/ OFA/alarm
- Statistics: Average mV measurement
- Buzzer

Standards:

- No. 2004/108/CE EMC directive
- No. 2006/95/CE 'DBT low voltage directive'
- No. 2011/65/UE, 2002/96/CE 'RoHS and WEEE directives'

Package dimensions:

- L 250mm x H 145mm x W 265mm

The kit includes:

- Rx electrode, 4m suction/injection pipe, 475 mV buffer solution to calibrate the electrode, wall fixing bracket and dowels, 2-in-1 electrode holder collar and product injection, suitable for DN50-63 ADPSTC pipes, foot filter.

📏 Dimensions

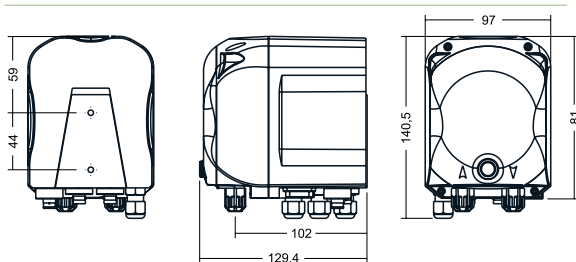

🔍 Models

| PRODUCT CODE | MODEL | POWER SUPPLY | FLOW RATE l/h | PRESSURE bar | WATT | PIPE | PKG | WEIGHT kg | VOLUME m ³ |
|------------------|------------------|--------------|---------------|--------------|------|------------|-----|-----------|-----------------------|
| ADS200301000A000 | SIMPOOL LIGHT Rx | 230 VAC | 3 | 1 | 15 | SANTOPRENE | 1 | 2.33 | 0.0096 |
| ADD200301000A000 | SIMPOOL PRO Rx | 230 VAC | 3 | 1 | 15 | SANTOPRENE | 1 | 2.33 | 0.0096 |

🛒 Installation kit

| PRODUCT CODE | DESCRIPTION | IMAGES |
|--------------|-----------------------------|--------|
| KITPDP0202 | Installation kit Simpool RX | |

CHEMICAL DOSING EQUIPMENT | 08/01

PERISTALTIC DOSING PUMPS

+ SIMPOOL PH **Optional**

| PRODUCT CODE | DESCRIPTION |
|--------------|--------------------------|
| ADSLG4 | Low level probe with BNC |



| PRODUCT CODE | MODEL | SIZE (ø x h) | VOLUME (l/h) |
|--------------|---------|--------------|--------------|
| ADTANK010 | PE tank | 500 x 680 | 100 L |
| ADTANK020 | PE tank | 620 x 800 | 200 L |



| PRODUCT CODE | MODEL | DN | CONN |
|--------------|-----------------------------|----|------|
| ADSP6000111 | Threaded T collar for pipes | 50 | G½" |
| ADSP6000113 | Threaded T collar for pipes | 63 | G½" |



| PRODUCT CODE | MODEL |
|--------------|-------------------------|
| ADSTS100N | PT100 Temperature probe |



| PRODUCT CODE | MODEL |
|--------------|-----------------------------|
| ADSP3600004 | Filter module + flow sensor |

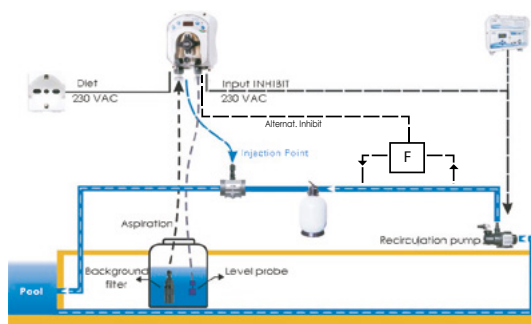

INSTALLATION EXAMPLE- AUTOMATIC / TIMER

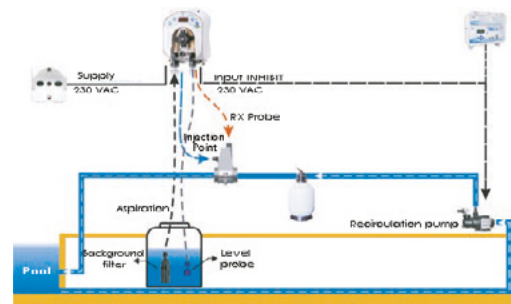

INSTALLATION EXAMPLE-RX

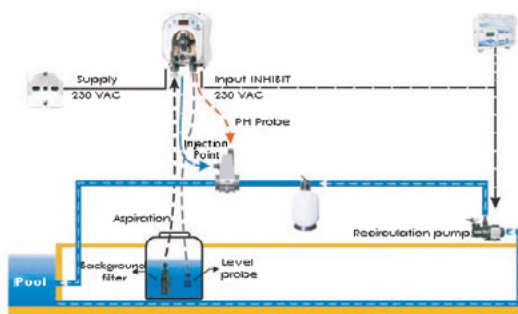

INSTALLATION EXAMPLE-PH

CHEMICAL DOSING EQUIPMENT

PERISTALTIC DOSING PUMPS

TECHNOPOOL 2 PH-RX

For private pools with double built-in pH and Rx tools. Suitable for the dosing of acid/alkaline correctors depending on the pH reading, and for the dosing of chlorine or other disinfectants depending on the Rx potential reading.



✓ Technical features

- Double peristaltic pump with pH and Rx built-in instruments to measure and adjust pH and Redox potential
- Proportional dosing capabilities
- Display with digital controls
- Measurement range: 5-9 pH, 0-999 mV
- Acoustic alarms
- Password protection
- Power supply: 220-230V 50/60Hz
- Supplied with installation kit and equipment for correct installation, including:
 - Suction/injection pipe
 - Wall fixing bracket and dowels

- pH and Rx electrodes
- No.2 2-1 Probe holder with injection valve for tube DN50-63
- Injection valves
- Foot filters (2x), compatible with level probes and flow and temperature probes

Standards:

- No. 2004/108/CE EMC directive
- No. 2006/95/CE 'DBT low voltage directive'
- No. 2011/65/UE, 2002/96/CE 'RoHS and WEEE directives'

Package dimensions:

- L 390mm x H 445mm x W 165mm

📏 Dimensions

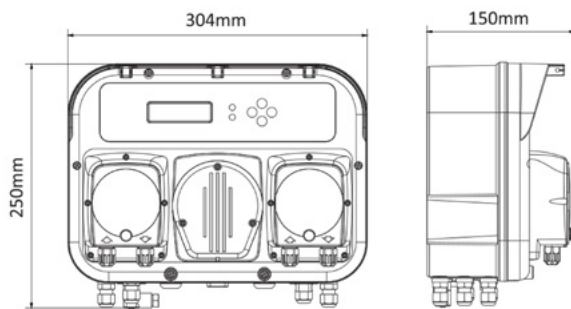

🔍 Models

| PRODUCT CODE | MODEL | POWER SUPPLY | FLOW RATE l/h | PRESSURE bar | WATT | PIPE | PKG | WEIGHT kg | VOLUME m³ |
|------------------|------------------------|--------------|---------------|--------------|------|-------|-----|-----------|-----------|
| AD0T00G0T000A100 | PDP Technopool 2 PH-RX | 230 VAC | 1.4/3 | 1 | 12 | 4 X 6 | 1 | 3.5 | 0.0096 |

📦 Installation kit

| PRODUCT CODE | DESCRIPTION |
|--------------|-------------------------------------|
| KITPDP0300 | Installation kit Technopool 2 PH-RX |

CHEMICAL DOSING EQUIPMENT | 08/01

PERISTALTIC DOSING PUMPS



TECHNOPOOL 3

For private pools with multifunctional built-in tools, including pH, temperature and Rx (upon request) Suitable for the dosing of acid/alkaline corrector, depending on the pH reading, the timed dosing of disinfectant (Hydrogen peroxide) and the water temperature. Also available with built-in Rx potential reading tool, for a proportional dosing of chlorine.

✓ Technical features

- Triple peristaltic pump with built-in timer and pH, Temperature and Redox instruments (T-pH-Rx model only).
- Acid/Alkaline corrector proportional dosing
- Timed dosing of 1-2 disinfectant products whose quantity is compensated depending on the temperature
- Disinfectant dosing proportioned to the Redox potential (T-pH-Rx model only)
- Display with digital controls
- Acoustic alarms
- Password protection
- Level probes compatible
- Flow sensor
- Connection to the circulation pump to allow the dosing (V1)
- Measurement range: 5-9 pH, 0-999 mV.
- Power supply 220-230V 50/60Hz
- Supplied with installation kit and equipment for correct

- installation, including:
- Suction/injection pipe
 - Wall fixing bracket and dowels
 - pH, temperature and Rx electrodes (Rx model only)
 - Buffer solutions
 - Probe holder collars
 - Injection valves
 - Foot filters
 - Compatible with level probes and flow and temperature probe

Standards:

- No. 2004/108/CE EMC directive
- No. 2006/95/CE 'DBT low voltage directive'
- No. 2011/65/UE, 2002/96/CE 'RoHS and WEEE directives'

Package dimensions:

- L 390mm x H 445mm x W 165mm

📏 Dimensions

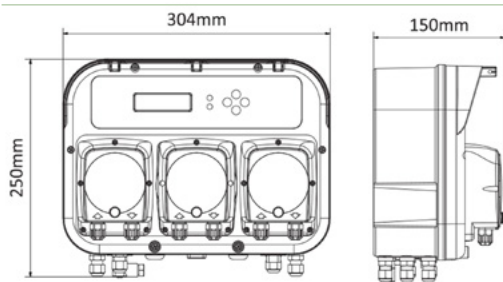

🔍 Models

| PRODUCT CODE | MODEL | PROBES | FLOW RATE l/h | PRESSURE bar | WATT | PIPE | PKG | WEIGHT kg | VOLUME m ³ |
|------------------|---------|-----------------|-----------------|--------------|------|-------|-----|-----------|-----------------------|
| AD5000G0G000A100 | T-PH-T | TEMP. - pH | 1.4 - 1.4 - 1.4 | 1 - 1 - 1 | 25 | 4 x 6 | 1 | 4.33 | 0.028 |
| AD4600G0G000A100 | T-PH-RX | TEMP. - pH - Rx | 1.4 - 1.4 - 1.4 | 1 - 1 - 1 | 25 | 4 x 6 | 1 | 4.33 | 0.028 |

🛒 Installation kit

| PRODUCT CODE | DESCRIPTION |
|--------------|-------------------------------|
| KITPDP0301 | Installation kit Technopool 3 |

PERISTALTIC DOSING PUMPS

+ Optional

| PRODUCT CODE | DESCRIPTION |
|--------------|---------------------------------------|
| ADSLG | Level probe with connector (optional) |



| PRODUCT CODE | MODEL | SIZE (ø x h) | VOLUME (l/h) |
|--------------|---------|--------------|--------------|
| ADTANK010 | PE tank | 500 x 680 | 100 L |
| ADTANK020 | PE tank | 620 x 800 | 200 L |
| ADTANK030 | PE tank | 710 x 890 | 300 L |



| PRODUCT CODE | MODEL |
|--------------|-------------------------|
| ADSTS100N | PT100 Temperature probe |

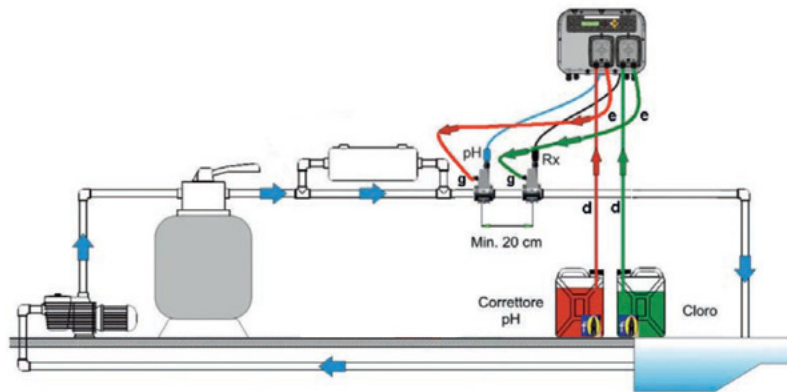

INSTALLATION EXAMPLE - TECHNOPOOL 3

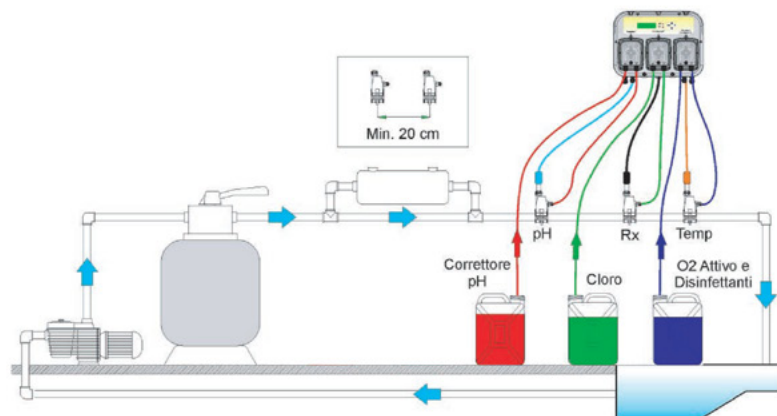

INSTALLATION EXAMPLE - TECHNOPOOL 3

CHEMICAL DOSING EQUIPMENT



Your global partner since 1974. Trusted for superior quality and exceptional innovations.



Head Office

AQUA S.p.A
42018 San Martino in Rio, Reggio Emilia
Italy - Via Crotti, 1
P: +39 0522 695805/85 - F: +39 0522 646160
aqua@aqua.it | www.aqua.it



Branches

AQUA WATER SYSTEMS LTD
Unit 135 Oak Drive Hartlebury Trading Estate,
Worcestershire, DY10 4JB
P: +44 (0)1299 251050, F: +44 (0)1299 253704
sales@askaqua.co.uk | www.askaqua.co.uk

AQUA FILTRACION S.A.
Pol. Ind. Castellbisbal Sud 08755
Castellbisbal, Barcelona
P: +34 (0)93 7711855, F: +34 (0)93 7711772
info@aqua.es | www.aqua.es

AQUA SU ARITIMI SAN. VE MUH. TIC. LTD. STI.
Ferhatpasa Mahallesi Maresal Fevzi Cakmak
Cad. No:45 Pk.34888 Atasehir / Istanbul - Turkey
P: +90 216 661 60 60, F: +90 216 661 68 50
info@aqua.com.tr | www.aqua.com.tr

AQUA S.p.A - POOL DIVISION
46043 Castiglione d. Stiviere, Mantova - Italy
P: +39 0376 671973 - F: +39 0376 940139
infpools@aqua.it | www.aqua.it

AQUA MIDDLE EAST FZC
1J-07/4 and 1J-07/3 - Hamriyah Free Zone
P.O.Box 42585 Sharjah - United Arab Emirates
P: +971 6 526 0563, F: +971 6 526 0564
contact@aqua-me.ae
www.aqua-me.ae

AQUA WATER SYSTEMS INDIA PVT LTD
4A/4B/4C-,Puttappa Industrial Estate
Mahadevapura Post, White Field Road,
Bangalore 560 048
P: 0091 80 4152 1313, F: 0091 80 4152 1414
contact@aquaindia.in | sales@aquaindia.in
www.aquaindia.in



AQUA GROUP RUS
Juridical Address:
107014, Egerskaya str, 1, Moscow, Russia
Residence Address:
127081, Chermianskaya str, 3, Moscow, Russia
P: +7 495 6458078, F: +7 495 969 2413
mail@aqua-italy.ru | www.aqua-italy.ru
www.aqua.it

AQUA GROUP LLC
Office : Regus – Sarayat EL Maadi, Egypt
Management & Warehouse : Plot no 2-2nd service
axe, 2nd Industrial Zone, October, Egypt
P: +20 2 3820 2259 | info@aqua.eg