

# SOLAR HEATED SHOWERS

## MODEL 'HAPPY'

### ✓ Technical features

- Hot and cold mixer/shower head and foot washer
- High density polyethylene column with chrome accessories
- Available in a straight or curved design
- Choice of 8 colours

### 📏 Dimensions

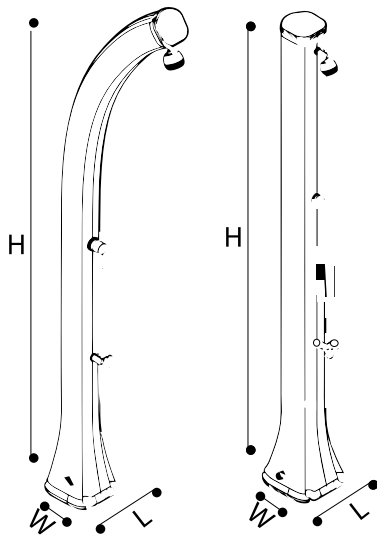

HAPPY XL



HAPPY STRAIGHT



### 🔍 Models

PRODUCT CODE	DESCRIPTION	DELIVERY CAPACITY 'L/M'		DIMENSIONS			WATER CAPACITY ltr	PACKING	WEIGHT kg	VOLUME m <sup>3</sup>
		2.5 BAR	3.5 BAR	H	W	L				
H-420	'HAPPY XL'	6	8	220	26	24.5	44	1	8	0.14
H-690	'HAPPY STRAIGHT'	-	-	215	29	26	40	1	9	0.18

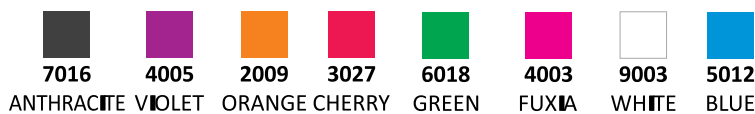

# SOLAR HEATED SHOWERS

## MODEL 'JOLLY'

### ✓ Technical features

- Hot and cold mixer/shower head and foot washer
- Aluminium column, protected with anti-corrosion treatment
- Chrome accessories
- Capacity: 25 litres
- Available in a straight or curved design
- Choice of 8 colours

### 📏 Dimensions

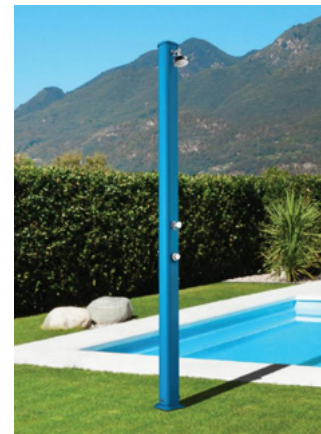
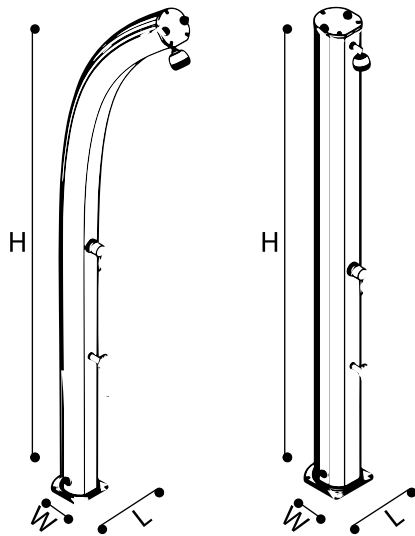

### 🔍 Models

PRODUCT CODE	DESCRIPTION	DELIVERY CAPACITY 'L/M'		DIMENSIONS			WATER CAPACITY ltr	PACKING	WEIGHT kg	VOLUME m <sup>3</sup>
		2.5 BAR	3.5 BAR	H	W	L				
A-520	'JOLLY'	8.5	9.2	226	16.5	15	25	1	13	0.17
A-620	'JOLLY STRAIGHT'	8.5	9.2	229	16.5	15	25	1	12	0.14



# SOLAR HEATED SHOWERS

## MODEL 'SPRING'

### ✓ Technical features

- Hot and cold mixer/shower head and foot washer
- Aluminium column, protected with anti-corrosion treatment
- Chrome accessories
- Available in a straight or curved design
- Choice of 8 colours

### 📏 Dimensions



SPRING STRAIGHT

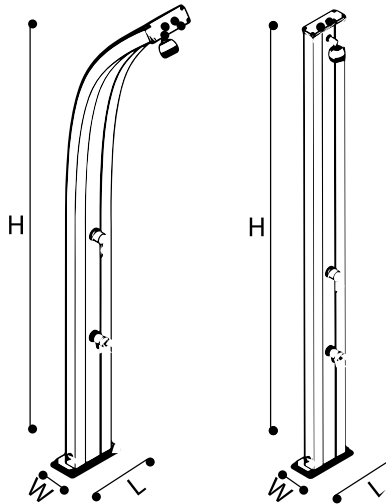

SPRING

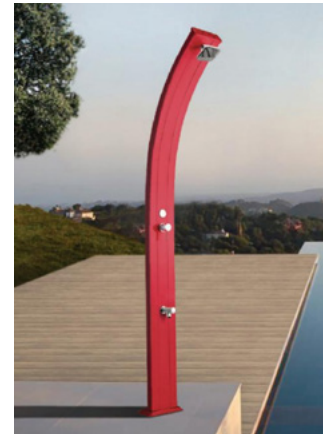

### 🔍 Models

PRODUCT CODE	DESCRIPTION	DELIVERY CAPACITY 'L/M'		DIMENSIONS			WATER CAPACITY ltr	PACKING	WEIGHT kg	VOLUME m <sup>3</sup>
		2.5 BAR	3.5 BAR	H	W	L				
A-120	'SPRING'	7	10	224	12	26	30	1	15	0.27
A-220	'SPRING STRAIGHT'	7	10	228	12	26	30	1	16	0.27

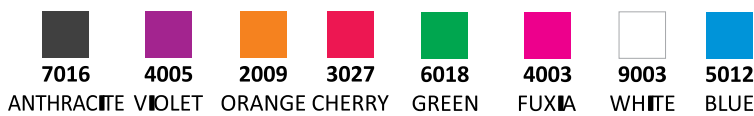

# SOLAR HEATED SHOWERS

## MODEL 'DADA'

A modern and contemporary design, providing elegance in any environment – Dada is the jewel of our production line.

### ✓ Technical features

- Hot and cold mixer/shower head and foot washer
- Aluminium column, protected with anti-corrosion treatment
- Chrome accessories
- Available in a straight or curved design
- Choice of 8 colours

### 📏 Dimensions

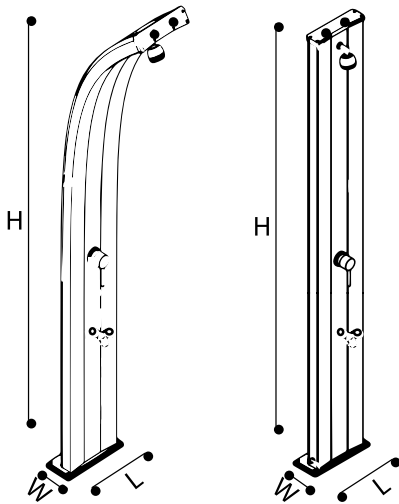

DADA STRAIGHT



DADA



### 🔍 Models

PRODUCT CODE	DESCRIPTION	DELIVERY CAPACITY 'L/M'		DIMENSIONS			WATER CAPACITY ltr	PACKING	WEIGHT kg	VOLUME m³
		2.5 BAR	3.5 BAR	H	W	L				
D-320	'DADA'	7	9.5	225	14	34	40	1	22	0.34
D-420	'DADA STRAIGHT'	7	9.5	229	14	34	40	1	20	0.17

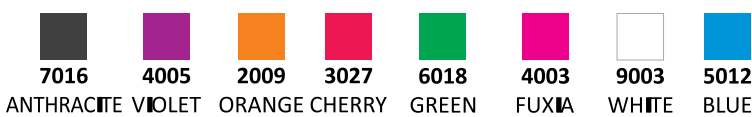

# SOLAR HEATED SHOWERS

## MODEL 'HAPPY GO' & 'JOLLY GO'

### ✓ Technical features

- Hot and cold mixer/shower head and foot washer
- High density polyethylene column with chrome accessories
- A great shower system for people on-the-go
- Easy to transport by car or campervan
- Easy installation. No special skills required
- Choice of 8 colours

### 📏 Dimensions

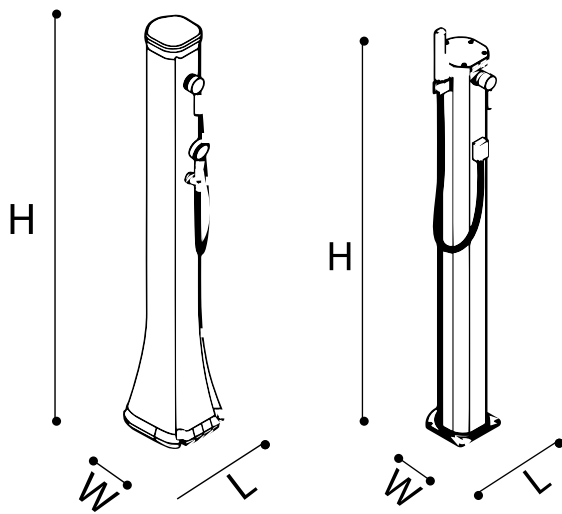

HAPPY GO



JOLLY GO



### 🔍 Models

PRODUCT CODE	DESCRIPTION	COLOR/FINISH	DIMENSIONS			WATER CAPACITY lit	PACKING	WEIGHT kg	VOLUME m³
			H	W	L				
HG-140	"HAPPY GO"	See Chart	120	29.5	27	20	1	4	0.11
JG-140	"JOLLY GO"	See Chart	120	16.5	15.5	20	1	10	0.07

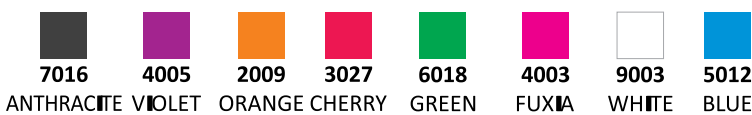



Your global partner since 1974. Trusted for superior quality and exceptional innovations.



## Head Office

### AQUA S.p.A

42018 San Martino in Rio, Reggio Emilia  
Italy - Via Crotti, 1  
P : +39 0522 695805/85 - F : +39 0522 646160  
aqua@aqua.it | www.aqua.it

### AQUA S.p.A - POOL DIVISION

46043 Castiglione d. Stiviere, Mantova - Italy  
P : +39 0376 671973 - F : +39 0376 940139  
infpools@aqua.it | www.aqua.it



## Branches

### AQUA WATER SYSTEMS LTD

Unit 135 Oak Drive Hartlebury Trading Estate,  
Worcestershire, DY10 4JB  
P : +44 (0)1299 251050, F : +44 (0)1299 253704  
sales@askaqua.co.uk | www.askaqua.co.uk

### AQUA FILTRACION S.A.

Pol. Ind. Castellbisbal Sud 08755  
Castellbisbal, Barcelona  
P : +34 (0)93 7711855, F : +34 (0)93 7711772  
info@aqua.es | www.aqua.es

### AQUA SU ARITIMI SAN. VE MUH. TIC. LTD. STI.

Ferhatpasa Mahallesi Maresal Fevzi Cakmak  
Cad. No:45 Pk.34888 Atasehir / Istanbul - Turkey  
P : +90 216 661 60 60, F : +90 216 661 68 50  
info@aqua.com.tr | www.aqua.com.tr

### AQUA MIDDLE EAST FZC

1J-07/4 and 1J-07/3 - Hamriyah Free Zone  
P.O.Box 42585 Sharjah - United Arab Emirates  
P : +971 6 526 0563, F : +971 6 526 0564  
contact@aqua-me.ae  
www.aqua-me.ae

### AQUA WATER SYSTEMS INDIA PVT LTD

4A/4B/4C-,Puttappa Industrial Estate  
Mahadevapura Post, White Field Road,  
Bangalore 560 048  
P : 0091 80 4152 1313, F : 0091 80 4152 1414  
contact@aquaindia.in | sales@aquaindia.in  
www.aquaindia.in

### AQUA GROUP RUS

Juridical Address:  
107014, Egerskaya str, 1, Moscow, Russia  
Residence Address:  
127081, Chermianskaya str, 3, Moscow, Russia  
P : +7 495 6458078, F : +7 495 969 2413  
mail@aqua-italy.ru | www.aqua-italy.ru  
www.aqua.it

### AQUA GROUP LLC

Office : Regus – Sarayat EL Maadi, Egypt  
Management & Warehouse : Plot no 2-2nd service  
axe, 2nd Industrial Zone, October, Egypt  
P : +20 2 3820 2259 | info@aqua.eg